

ITEM

BREEZE 250 DTO 63

Color: FLINT



berlinpackaging.eu

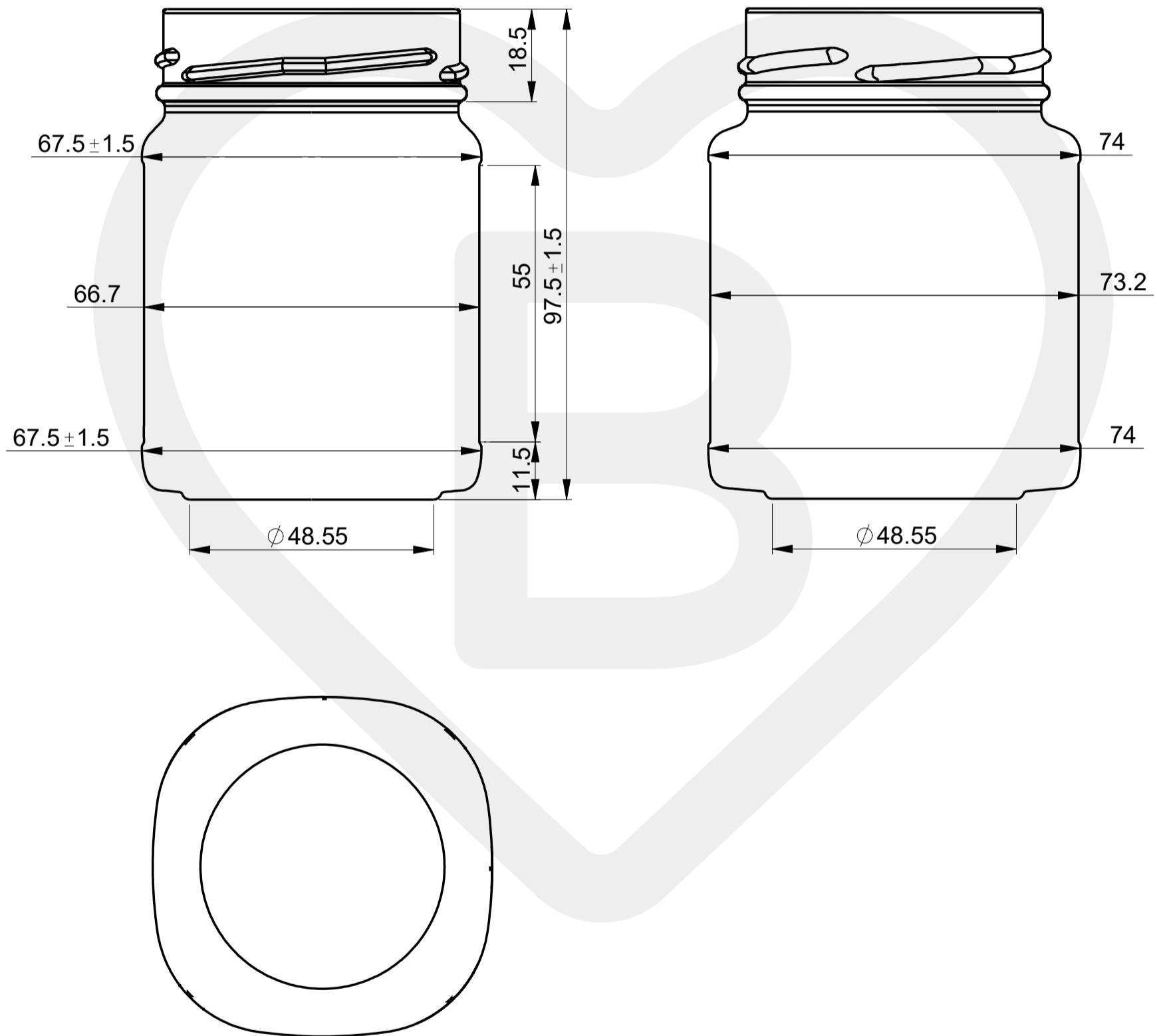

This drawing is approximate and not binding - Berlin Packaging does not assume any guarantee or obligation for use of this drawing or for information contained therein

Brimful capacity (c.c.):	250	Weight (g):	185
Finish:	TO 63 DEEP	Fill Point:	-

For full technical details please contact sales representative

ITEM CODE: **10282**